

# MMBT2222LT1G, MMBT2222ALT1G

## General Purpose Transistors

### NPN Silicon

#### Features

- These Devices are Pb-Free, Halogen Free/BFR Free and are RoHS Compliant

#### MAXIMUM RATINGS

Rating	Symbol	Value	Unit
Collector - Emitter Voltage MMBT2222LT1G MMBT2222ALT1G	$V_{CEO}$	30 40	Vdc
Collector - Base Voltage MMBT2222LT1G MMBT2222ALT1G	$V_{CBO}$	60 75	Vdc
Emitter - Base Voltage MMBT2222LT1G MMBT2222ALT1G	$V_{EBO}$	5.0 6.0	Vdc
Collector Current - Continuous	$I_C$	600	mAdc
Collector Current - Peak (Note 3)	$I_{CM}$	1100	mAdc

#### THERMAL CHARACTERISTICS

Characteristic	Symbol	Max	Unit
Total Device Dissipation FR-5 Board (Note 1) $T_A = 25^\circ\text{C}$ Derate above $25^\circ\text{C}$	$P_D$	225 1.8	mW mW/ $^\circ\text{C}$
Thermal Resistance, Junction-to-Ambient	$R_{\theta JA}$	556	$^\circ\text{C}/\text{W}$
Total Device Dissipation Alumina Substrate (Note 2) $T_A = 25^\circ\text{C}$ Derate above $25^\circ\text{C}$	$P_D$	300 2.4	mW mW/ $^\circ\text{C}$
Thermal Resistance, Junction-to-Ambient	$R_{\theta JA}$	417	$^\circ\text{C}/\text{W}$
Junction and Storage Temperature Range	$T_J, T_{stg}$	-55 to +150	$^\circ\text{C}$

Stresses exceeding Maximum Ratings may damage the device. Maximum Ratings are stress ratings only. Functional operation above the Recommended Operating Conditions is not implied. Extended exposure to stresses above the Recommended Operating Conditions may affect device reliability.

1. FR-5 =  $1.0 \times 0.75 \times 0.062$  in.
2. Alumina =  $0.4 \times 0.3 \times 0.024$  in. 99.5% alumina.
3. Reference SOA curve.



ON Semiconductor®

<http://onsemi.com>

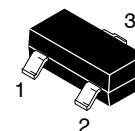
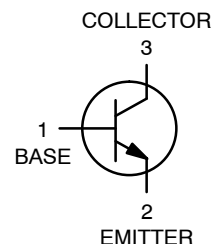

SOT-23  
CASE 318  
STYLE 6

#### MARKING DIAGRAM

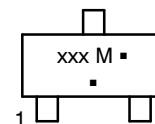

xxx = 1P or M1B  
M = Date Code\*  
▪ = Pb-Free Package

(Note: Microdot may be in either location)

\*Date Code orientation and/or overbar may vary depending upon manufacturing location.

#### ORDERING INFORMATION

See detailed ordering and shipping information in the package dimensions section on page 6 of this data sheet.

# MMBT2222LT1G, MMBT2222ALT1G

## ELECTRICAL CHARACTERISTICS (T<sub>A</sub> = 25°C unless otherwise noted)

Characteristic		Symbol	Min	Max	Unit
<b>OFF CHARACTERISTICS</b>					
Collector – Emitter Breakdown Voltage (I <sub>C</sub> = 10 mAdc, I <sub>B</sub> = 0) MMBT2222A	MMBT2222	V <sub>(BR)CEO</sub>	30 40	– –	Vdc
Collector – Base Breakdown Voltage (I <sub>C</sub> = 10 μAdc, I <sub>E</sub> = 0) MMBT2222A	MMBT2222	V <sub>(BR)CBO</sub>	60 75	– –	Vdc
Emitter – Base Breakdown Voltage (I <sub>E</sub> = 10 μAdc, I <sub>C</sub> = 0) MMBT2222A	MMBT2222	V <sub>(BR)EBO</sub>	5.0 6.0	– –	Vdc
Collector Cutoff Current (V <sub>CE</sub> = 60 Vdc, V <sub>EB(off)</sub> = 3.0 Vdc)	MMBT2222A	I <sub>CEX</sub>	–	10	nAdc
Collector Cutoff Current (V <sub>CB</sub> = 50 Vdc, I <sub>E</sub> = 0) (V <sub>CB</sub> = 60 Vdc, I <sub>E</sub> = 0) (V <sub>CB</sub> = 50 Vdc, I <sub>E</sub> = 0, T <sub>A</sub> = 125°C) (V <sub>CB</sub> = 60 Vdc, I <sub>E</sub> = 0, T <sub>A</sub> = 125°C)	MMBT2222 MMBT2222A MMBT2222 MMBT2222A	I <sub>CBO</sub>	– – – –	0.01 0.01 10 10	μAdc
Emitter Cutoff Current (V <sub>EB</sub> = 3.0 Vdc, I <sub>C</sub> = 0)	MMBT2222A	I <sub>EBO</sub>	–	100	nAdc
Base Cutoff Current (V <sub>CE</sub> = 60 Vdc, V <sub>EB(off)</sub> = 3.0 Vdc)	MMBT2222A	I <sub>BL</sub>	–	20	nAdc
<b>ON CHARACTERISTICS</b>					
DC Current Gain (I <sub>C</sub> = 0.1 mAdc, V <sub>CE</sub> = 10 Vdc) (I <sub>C</sub> = 1.0 mAdc, V <sub>CE</sub> = 10 Vdc) (I <sub>C</sub> = 10 mAdc, V <sub>CE</sub> = 10 Vdc) (I <sub>C</sub> = 10 mAdc, V <sub>CE</sub> = 10 Vdc, T <sub>A</sub> = –55°C) (I <sub>C</sub> = 150 mAdc, V <sub>CE</sub> = 10 Vdc) (Note 4) (I <sub>C</sub> = 150 mAdc, V <sub>CE</sub> = 1.0 Vdc) (Note 4) (I <sub>C</sub> = 500 mAdc, V <sub>CE</sub> = 10 Vdc) (Note 4)	MMBT2222A only     MMBT2222 MMBT2222A	h <sub>FE</sub>	35 50 75 35 100 50 30 40	– – – – 300 – – –	–
Collector – Emitter Saturation Voltage (Note 4) (I <sub>C</sub> = 150 mAdc, I <sub>B</sub> = 15 mAdc)  (I <sub>C</sub> = 500 mAdc, I <sub>B</sub> = 50 mAdc)	MMBT2222 MMBT2222A  MMBT2222 MMBT2222A	V <sub>CE(sat)</sub>	– – – –	0.4 0.3 1.6 1.0	Vdc
Base – Emitter Saturation Voltage (Note 4) (I <sub>C</sub> = 150 mAdc, I <sub>B</sub> = 15 mAdc)  (I <sub>C</sub> = 500 mAdc, I <sub>B</sub> = 50 mAdc)	MMBT2222 MMBT2222A  MMBT2222 MMBT2222A	V <sub>BE(sat)</sub>	– 0.6 – –	1.3 1.2 2.6 2.0	Vdc
<b>SMALL-SIGNAL CHARACTERISTICS</b>					
Current – Gain – Bandwidth Product (Note 5) (I <sub>C</sub> = 20 mAdc, V <sub>CE</sub> = 20 Vdc, f = 100 MHz)	MMBT2222 MMBT2222A	f <sub>T</sub>	250 300	– –	MHz
Output Capacitance (V <sub>CB</sub> = 10 Vdc, I <sub>E</sub> = 0, f = 1.0 MHz)		C <sub>obo</sub>	–	8.0	pF
Input Capacitance (V <sub>EB</sub> = 0.5 Vdc, I <sub>C</sub> = 0, f = 1.0 MHz)	MMBT2222 MMBT2222A	C <sub>ibo</sub>	– –	30 25	pF
Input Impedance (I <sub>C</sub> = 1.0 mAdc, V <sub>CE</sub> = 10 Vdc, f = 1.0 kHz) (I <sub>C</sub> = 10 mAdc, V <sub>CE</sub> = 10 Vdc, f = 1.0 kHz)	MMBT2222A MMBT2222A	h <sub>ie</sub>	2.0 0.25	8.0 1.25	kΩ
Voltage Feedback Ratio (I <sub>C</sub> = 1.0 mAdc, V <sub>CE</sub> = 10 Vdc, f = 1.0 kHz) (I <sub>C</sub> = 10 mAdc, V <sub>CE</sub> = 10 Vdc, f = 1.0 kHz)	MMBT2222A MMBT2222A	h <sub>re</sub>	– –	8.0 4.0	X 10 <sup>–4</sup>
Small – Signal Current Gain (I <sub>C</sub> = 1.0 mAdc, V <sub>CE</sub> = 10 Vdc, f = 1.0 kHz) (I <sub>C</sub> = 10 mAdc, V <sub>CE</sub> = 10 Vdc, f = 1.0 kHz)	MMBT2222A MMBT2222A	h <sub>fe</sub>	50 75	300 375	–
Output Admittance (I <sub>C</sub> = 1.0 mAdc, V <sub>CE</sub> = 10 Vdc, f = 1.0 kHz) (I <sub>C</sub> = 10 mAdc, V <sub>CE</sub> = 10 Vdc, f = 1.0 kHz)	MMBT2222A MMBT2222A	h <sub>oe</sub>	5.0 25	35 200	μmhos

# MMBT2222LT1G, MMBT2222ALT1G

## ELECTRICAL CHARACTERISTICS ( $T_A = 25^\circ\text{C}$ unless otherwise noted)

Characteristic	Symbol	Min	Max	Unit
<b>SMALL-SIGNAL CHARACTERISTICS</b>				
Collector Base Time Constant ( $I_E = 20\text{ mAdc}$ , $V_{CB} = 20\text{ Vdc}$ , $f = 31.8\text{ MHz}$ )	MMBT2222A		150	ps
Noise Figure ( $I_C = 100\ \mu\text{Adc}$ , $V_{CE} = 10\text{ Vdc}$ , $R_S = 1.0\text{ k}\Omega$ , $f = 1.0\text{ kHz}$ )	MMBT2222A		4.0	dB

## SWITCHING CHARACTERISTICS (MMBT2222A only)

Delay Time	$(V_{CC} = 30\text{ Vdc}$ , $V_{BE(\text{off})} = -0.5\text{ Vdc}$ , $I_C = 150\text{ mAdc}$ , $I_{B1} = 15\text{ mAdc}$ )	$t_d$	-	10	ns
Rise Time		$t_r$	-	25	
Storage Time	$(V_{CC} = 30\text{ Vdc}$ , $I_C = 150\text{ mAdc}$ , $I_{B1} = I_{B2} = 15\text{ mAdc}$ )	$t_s$	-	225	ns
Fall Time		$t_f$	-	60	

- Pulse Test: Pulse Width  $\leq 300\ \mu\text{s}$ , Duty Cycle  $\leq 2.0\%$ .
- $f_T$  is defined as the frequency at which  $|h_{fe}|$  extrapolates to unity.

## SWITCHING TIME EQUIVALENT TEST CIRCUITS

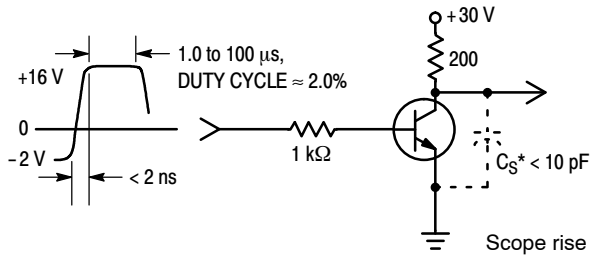

Figure 1. Turn-On Time

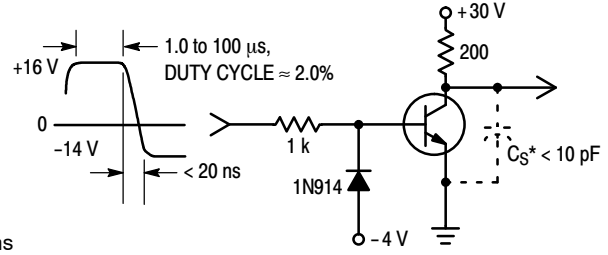

Figure 2. Turn-Off Time

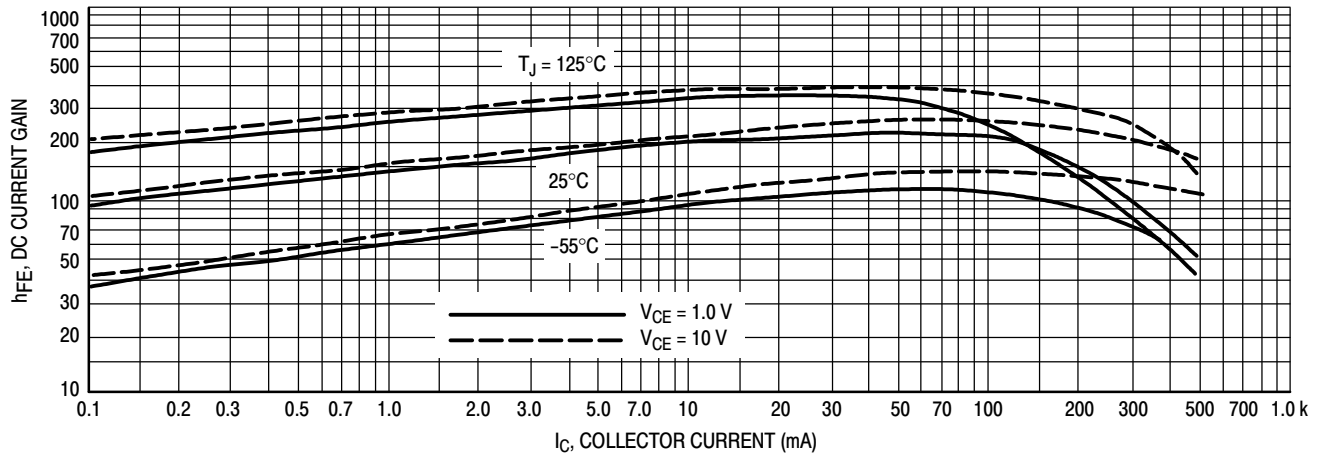

Figure 3. DC Current Gain

# MMBT2222LT1G, MMBT2222ALT1G

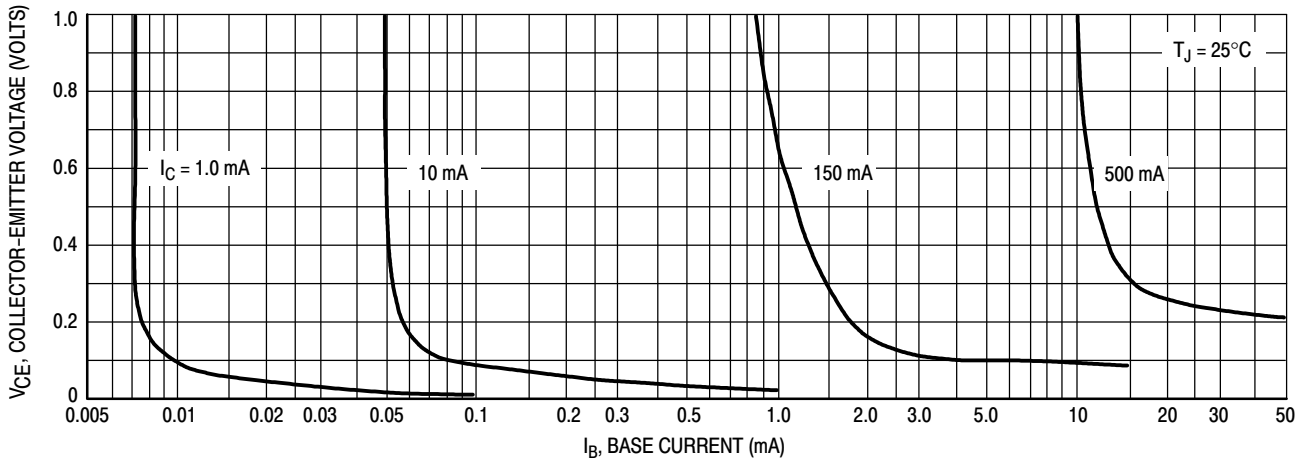

Figure 4. Collector Saturation Region

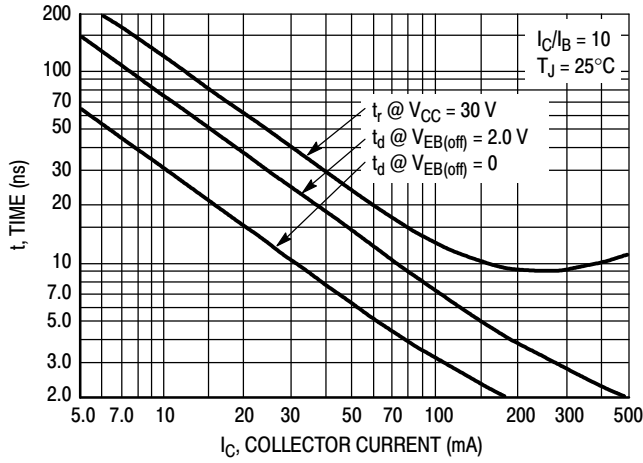

Figure 5. Turn-On Time

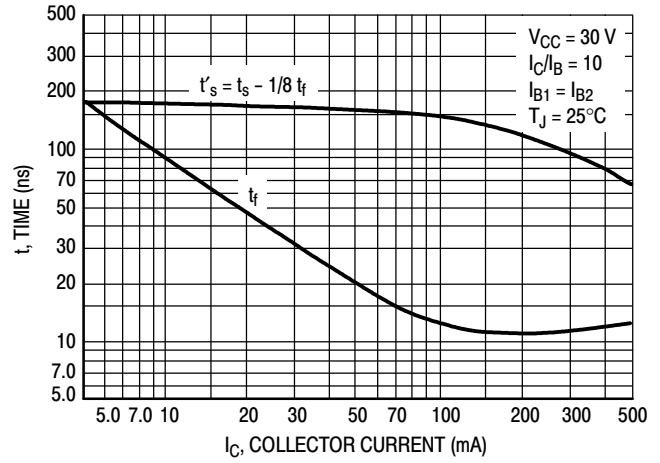

Figure 6. Turn-Off Time

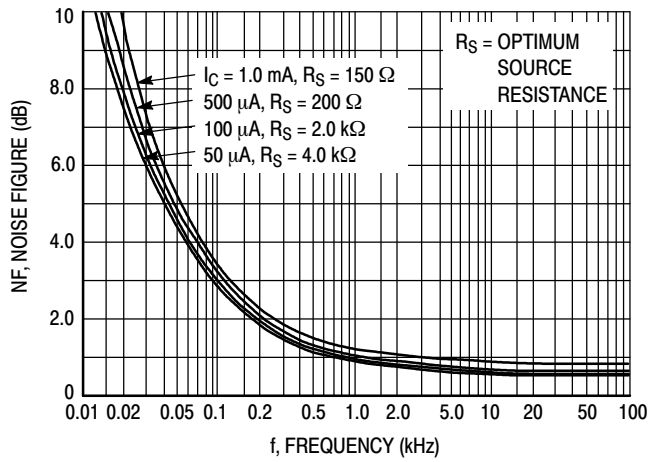

Figure 7. Frequency Effects

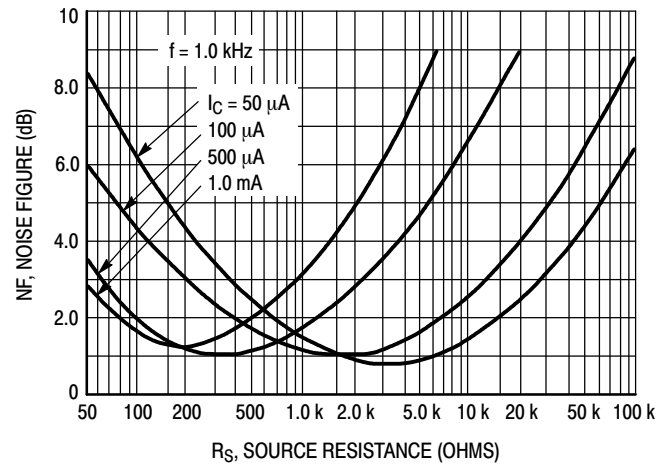

Figure 8. Source Resistance Effects

# MMBT2222LT1G, MMBT2222ALT1G

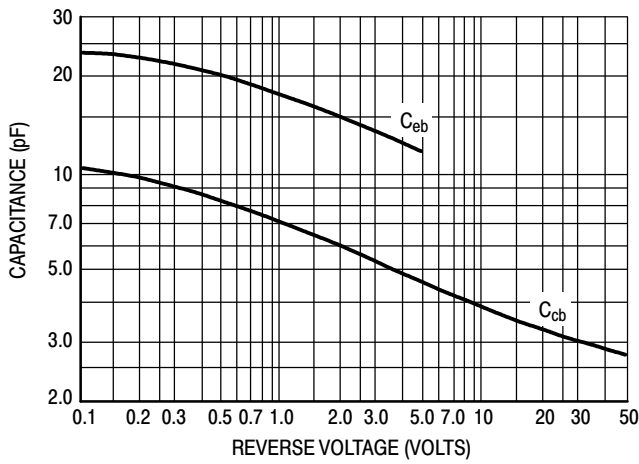

Figure 9. Capacitances

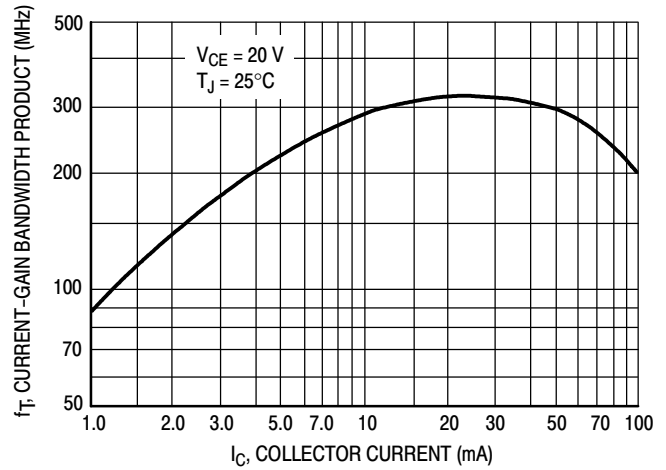

Figure 10. Current-Gain Bandwidth Product

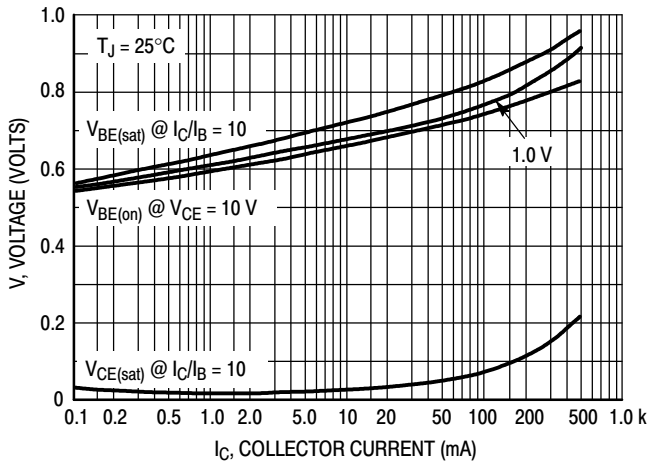

Figure 11. "On" Voltages

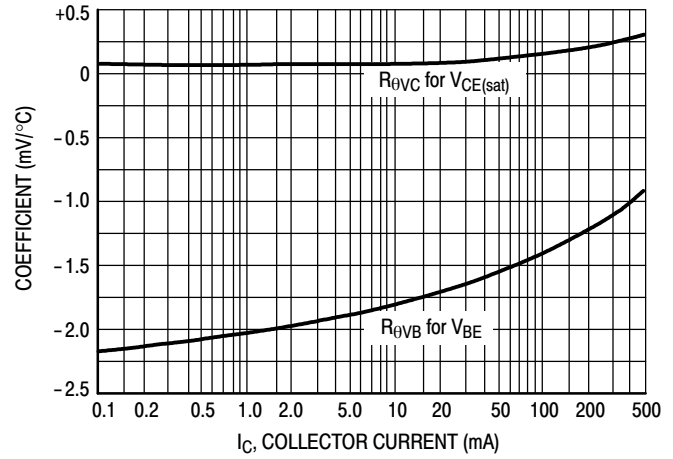

Figure 12. Temperature Coefficients

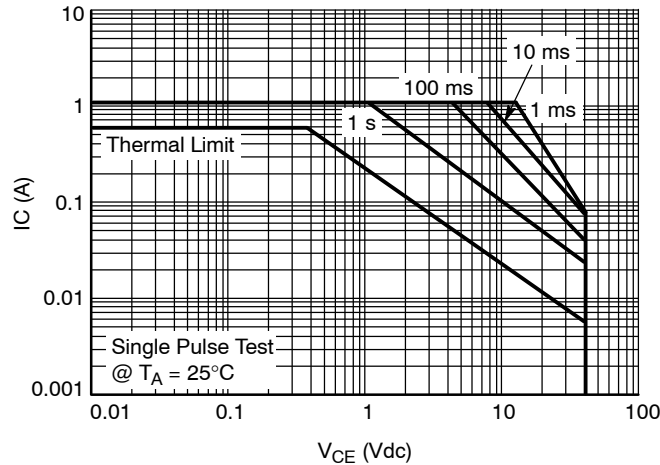

Figure 13. Safe Operating Area

## MMBT2222LT1G, MMBT2222ALT1G

### ORDERING INFORMATION

Device	Specific Marking Code	Package	Shipping <sup>†</sup>
MMBT2222LT1G	M1B	SOT-23 (Pb-Free)	3000 / Tape & Reel
MMBT2222ALT1G	1P	SOT-23 (Pb-Free)	3000 / Tape & Reel
MMBT2222LT3G	M1B	SOT-23 (Pb-Free)	10,000 / Tape & Reel
MMBT2222ALT3G	1P	SOT-23 (Pb-Free)	10,000 / Tape & Reel

<sup>†</sup>For information on tape and reel specifications, including part orientation and tape sizes, please refer to our Tape and Reel Packaging Specifications Brochure, BRD8011/D.

# MMBT2222LT1G, MMBT2222ALT1G

## PACKAGE DIMENSIONS

SOT-23 (TO-236)  
CASE 318-08  
ISSUE AN

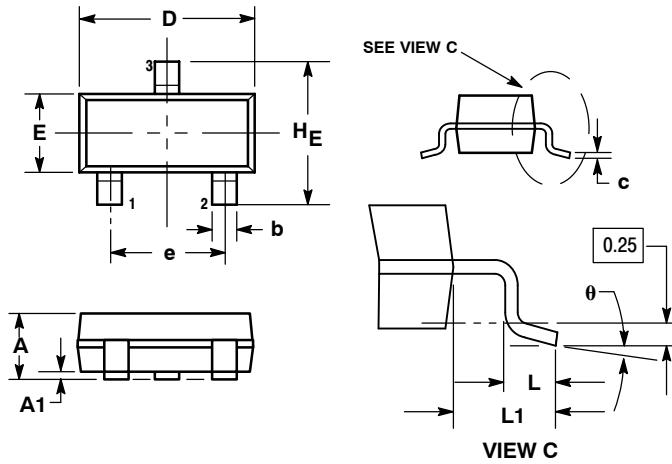

### NOTES:

1. DIMENSIONING AND TOLERANCING PER ANSI Y14.5M, 1982.
2. CONTROLLING DIMENSION: INCH.
3. MAXIMUM LEAD THICKNESS INCLUDES LEAD FINISH THICKNESS. MINIMUM LEAD THICKNESS IS THE MINIMUM THICKNESS OF BASE MATERIAL.
4. 318-01 THRU -07 AND -09 OBSOLETE, NEW STANDARD 318-08.

DIM	MILLIMETERS			INCHES		
	MIN	NOM	MAX	MIN	NOM	MAX
A	0.89	1.00	1.11	0.035	0.040	0.044
A1	0.01	0.06	0.10	0.001	0.002	0.004
b	0.37	0.44	0.50	0.015	0.018	0.020
c	0.09	0.13	0.18	0.003	0.005	0.007
D	2.80	2.90	3.04	0.110	0.114	0.120
E	1.20	1.30	1.40	0.047	0.051	0.055
e	1.78	1.90	2.04	0.070	0.075	0.081
L	0.10	0.20	0.30	0.004	0.008	0.012
L1	0.35	0.54	0.69	0.014	0.021	0.029
HE	2.10	2.40	2.64	0.083	0.094	0.104

### STYLE 6:

1. BASE
2. EMITTER
3. COLLECTOR

### SOLDERING FOOTPRINT\*

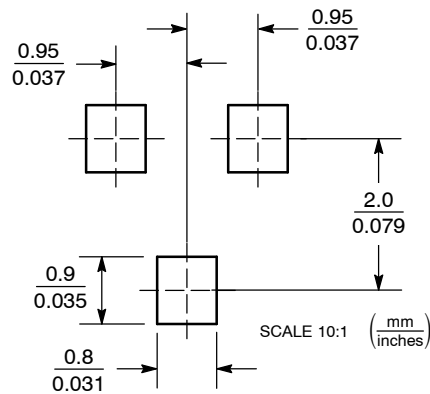

\*For additional information on our Pb-Free strategy and soldering details, please download the ON Semiconductor Soldering and Mounting Techniques Reference Manual, SOLDERRM/D.

ON Semiconductor and are registered trademarks of Semiconductor Components Industries, LLC (SCILLC). SCILLC reserves the right to make changes without further notice to any products herein. SCILLC makes no warranty, representation or guarantee regarding the suitability of its products for any particular purpose, nor does SCILLC assume any liability arising out of the application or use of any product or circuit, and specifically disclaims any and all liability, including without limitation special, consequential or incidental damages. "Typical" parameters which may be provided in SCILLC data sheets and/or specifications can and do vary in different applications and actual performance may vary over time. All operating parameters, including "Typicals" must be validated for each customer application by customer's technical experts. SCILLC does not convey any license under its patent rights nor the rights of others. SCILLC products are not designed, intended, or authorized for use as components in systems intended for surgical implant into the body, or other applications intended to support or sustain life, or for any other application in which the failure of the SCILLC product could create a situation where personal injury or death may occur. Should Buyer purchase or use SCILLC products for any such unintended or unauthorized application, Buyer shall indemnify and hold SCILLC and its officers, employees, subsidiaries, affiliates, and distributors harmless against all claims, costs, damages, and expenses, and reasonable attorney fees arising out of, directly or indirectly, any claim of personal injury or death associated with such unintended or unauthorized use, even if such claim alleges that SCILLC was negligent regarding the design or manufacture of the part. SCILLC is an Equal Opportunity/Affirmative Action Employer. This literature is subject to all applicable copyright laws and is not for resale in any manner.

### PUBLICATION ORDERING INFORMATION

**LITERATURE FULFILLMENT:**  
Literature Distribution Center for ON Semiconductor  
P.O. Box 5163, Denver, Colorado 80217 USA  
**Phone:** 303-675-2175 or 800-344-3860 Toll Free USA/Canada  
**Fax:** 303-675-2176 or 800-344-3867 Toll Free USA/Canada  
**Email:** orderlit@onsemi.com

**N. American Technical Support:** 800-282-9855 Toll Free  
USA/Canada  
**Europe, Middle East and Africa Technical Support:**  
Phone: 421 33 790 2910  
**Japan Customer Focus Center**  
Phone: 81-3-5773-3850

**ON Semiconductor Website:** [www.onsemi.com](http://www.onsemi.com)  
**Order Literature:** <http://www.onsemi.com/orderlit>

For additional information, please contact your local Sales Representative